

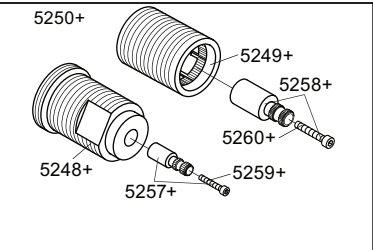

5100

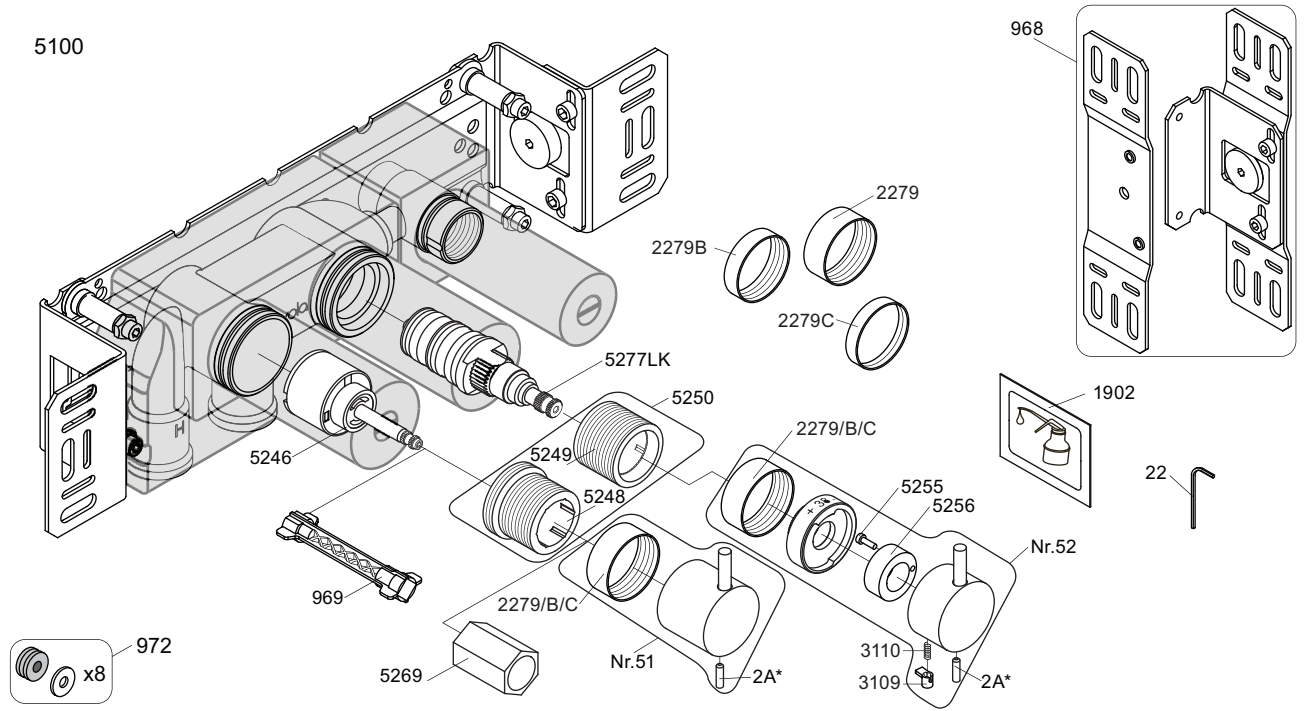

2A*  Color

VR2A-Steel: Standard
 VR2A-F60: F17-F27-F60
 VR2A-F63: F63-F64
 VR2A-F65: F19-F65-F70

NR51: VR5251, VR2279+B+C, VR2A
 NR52: VR2A, VR5252, VR5253, VR5255, VR5256, VR2279+B+C, VR3113, VR2A
 VR3113: VR3109, VR3110, VR5255
 VR5250+: VR5248+, VR5249+, VR5257, VR5258, VR5259, VR5260
 VR5257+: VR5257+, VR5259+
 VR5258+: VR5258+, VR5260+

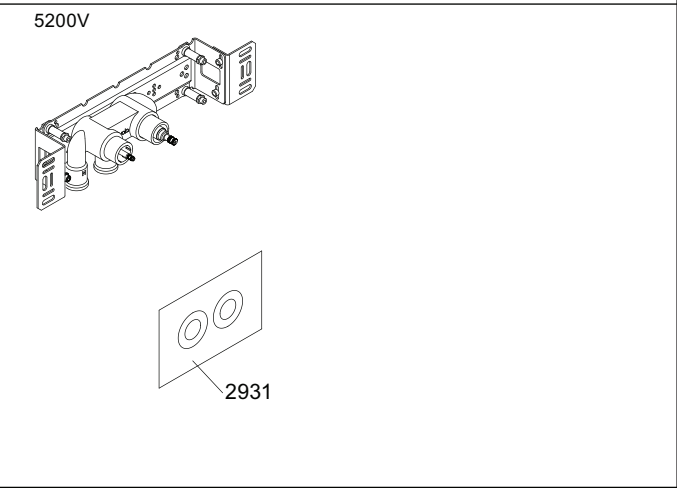
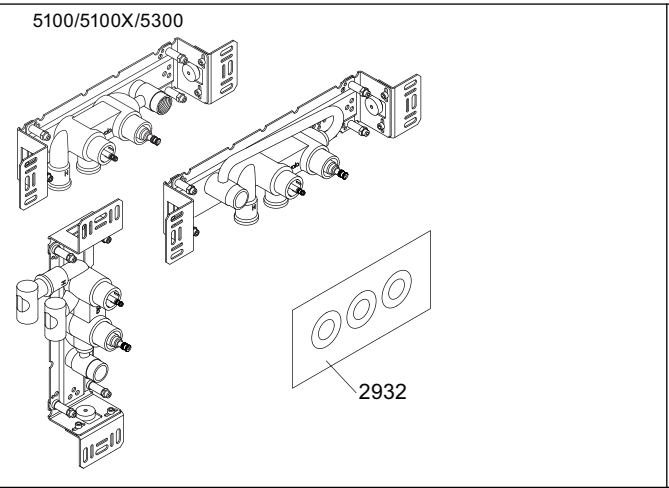

vola
 Lunavej 2
 DK-8700 Horsens
 Tlf : + 45 7023 5500
 sales@vola.com
 www.vola.com

VOLA 5100
 5100X, 5200V, 5300

Date	May 22
Rev.	4
Sheet	SB 10.51